

# NOTICE DE MONTAGE CLAUSTRA FIXE

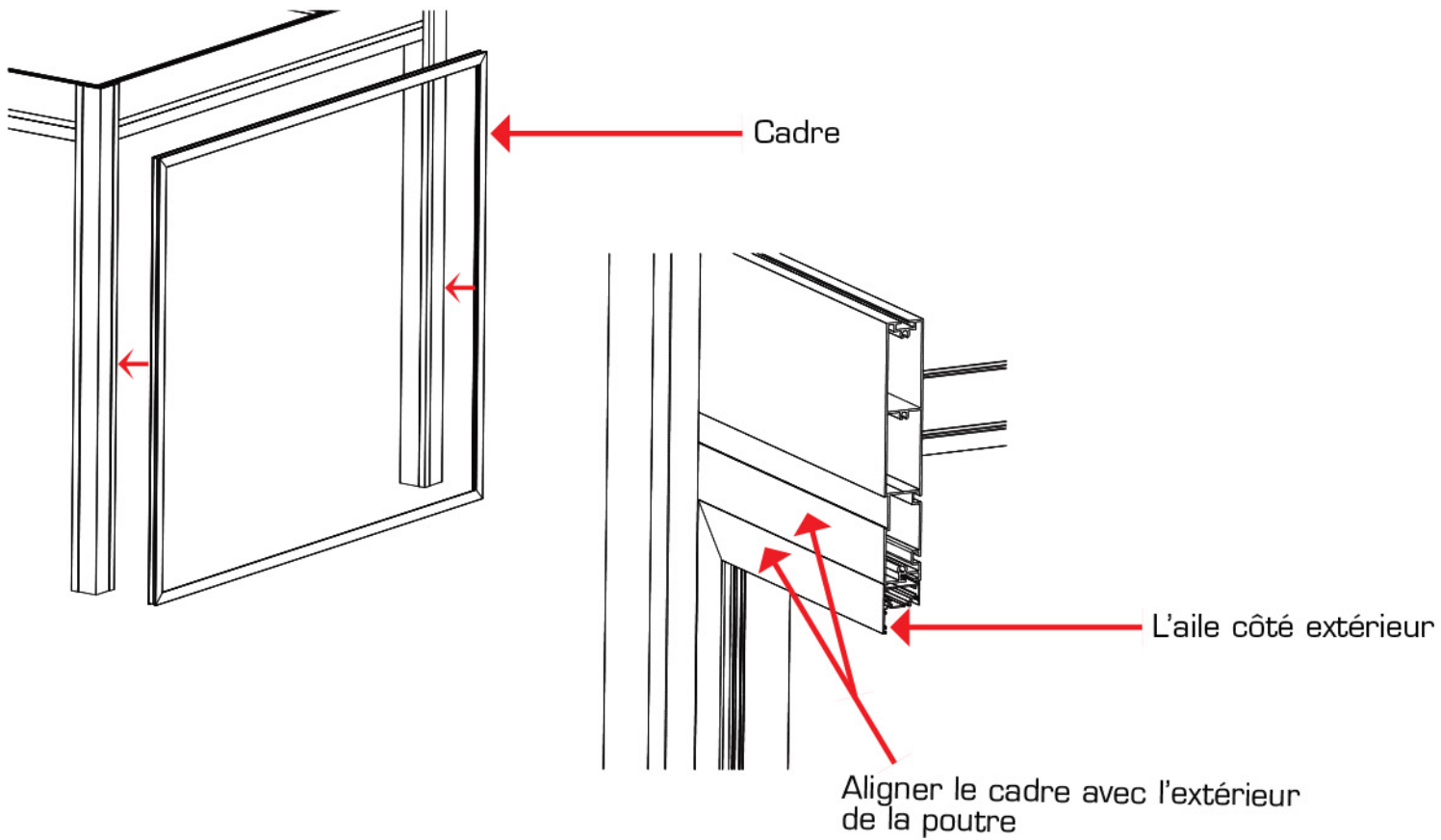

## OU Monter le cadre à l'emplacement prévu



## OU Fixation du cadre

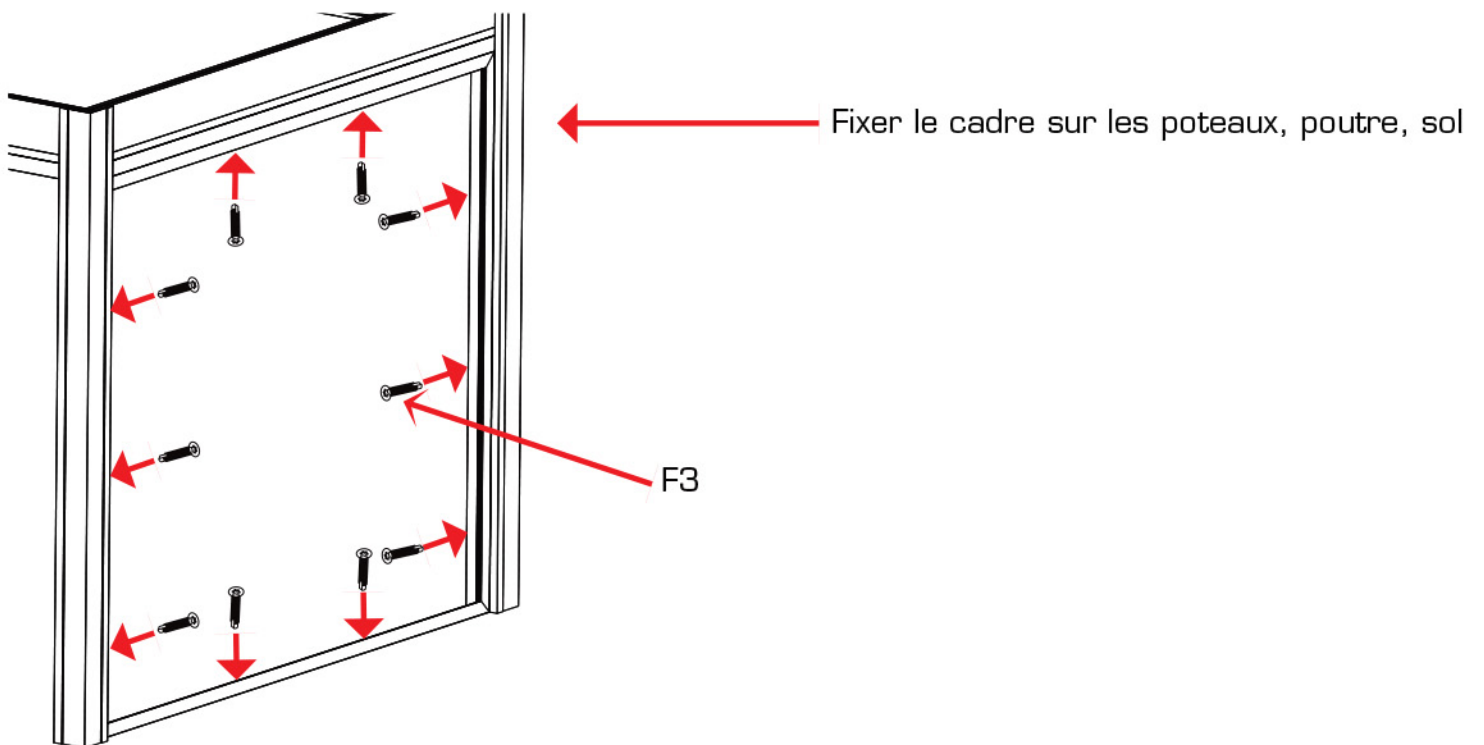

# Remplissage panneaux sandwich

## **OU** Monter la parclose supérieure

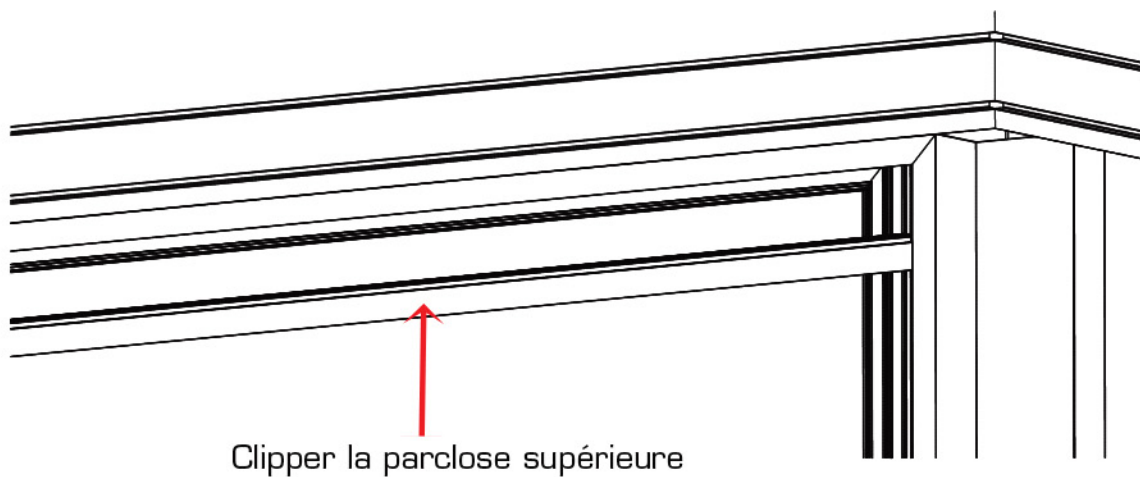

## **OU** Insérer le premier panneau

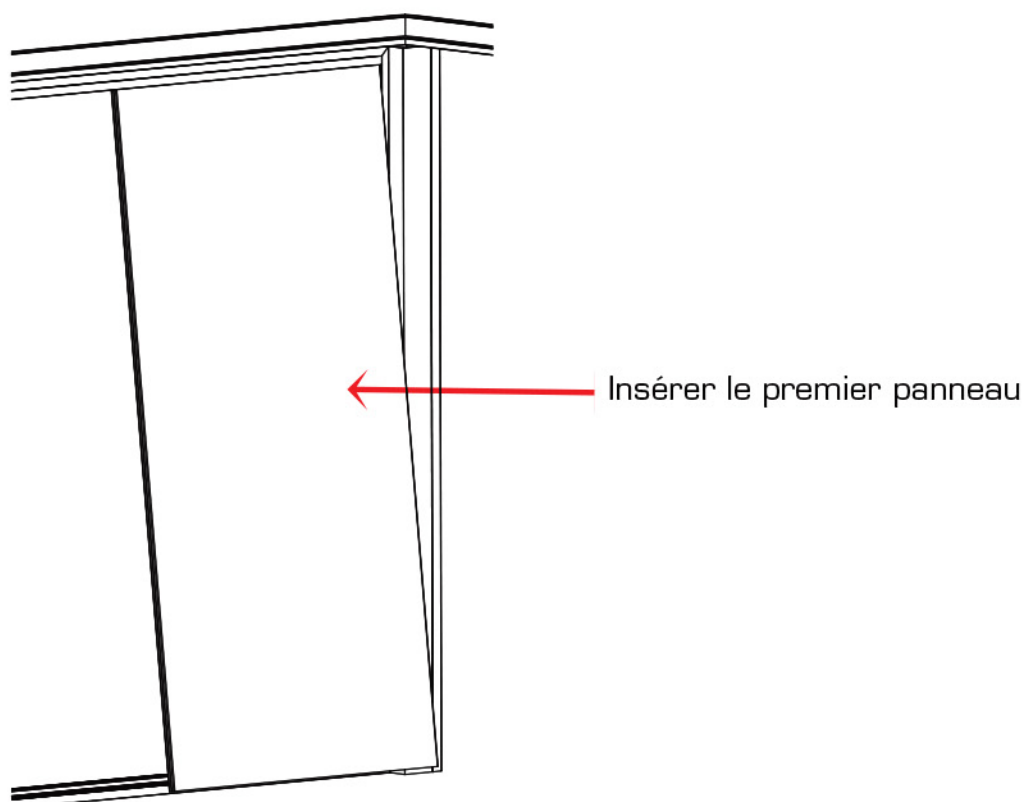

## OU Montage plat de jonction et calage

Insérer le plat de jonction dans la rainure du panneau

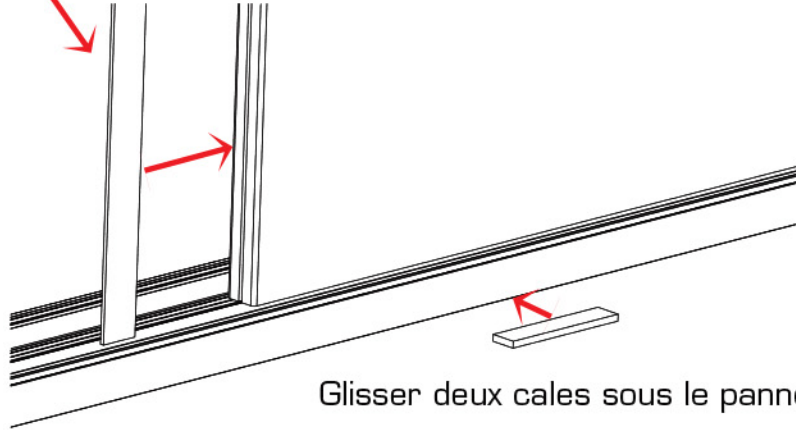

Glisser deux cales sous le panneau

## OU Montage des panneaux

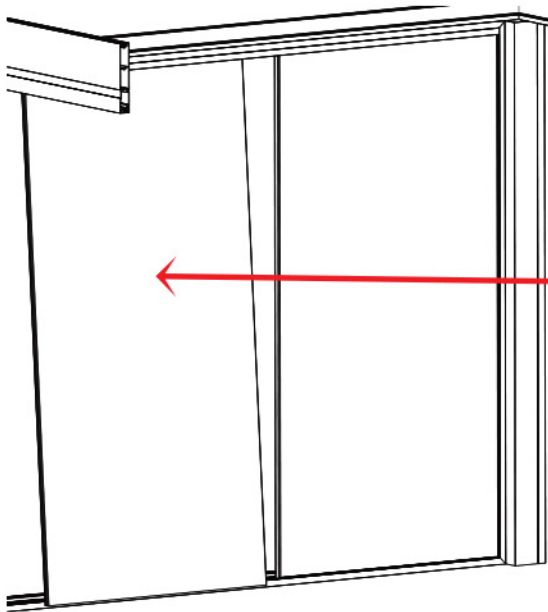

Insérer le 2ème panneau

Insérer les panneaux suivants à l'aide des plats de jonction

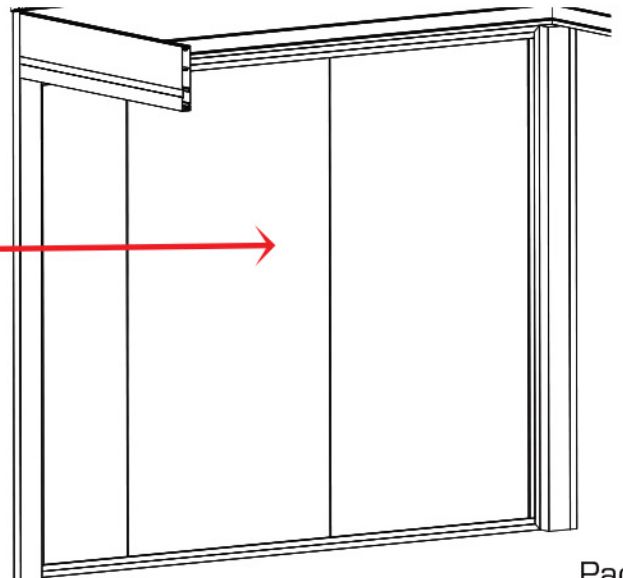

⚠ Le plus petit panneau est à insérer en dernier

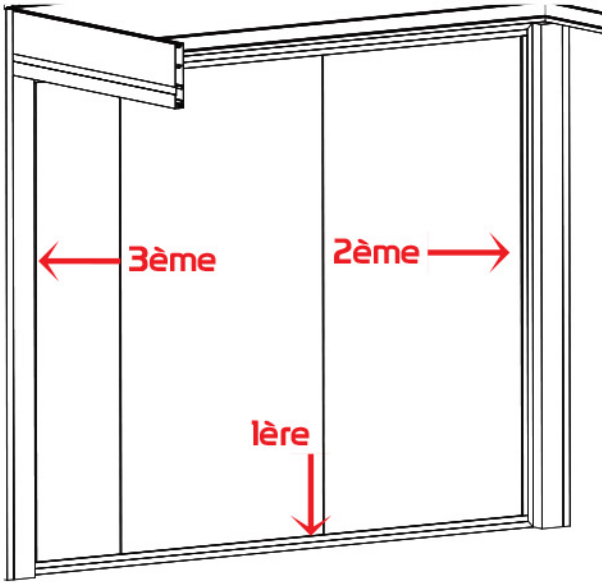

Clipper les trois dernières parclores

# Remplissage vitrage

## **OU** Montage des parclozes supérieures

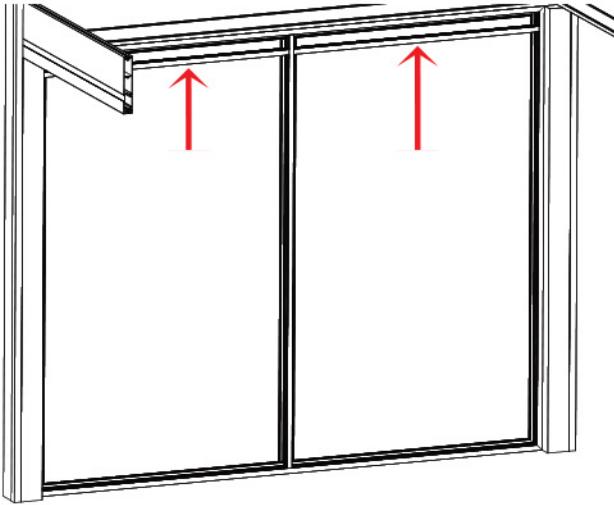

Clipper les parclozes supérieures

## **OU** Montage du premier verre

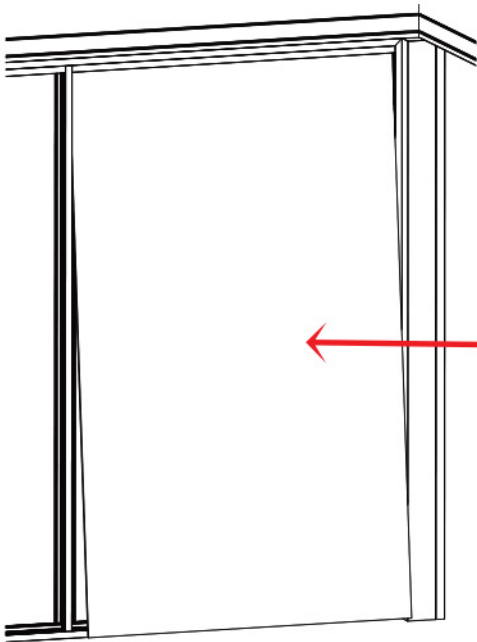

← Insérer le vitrage dans la première trame

## **OU** Montage du premier verre

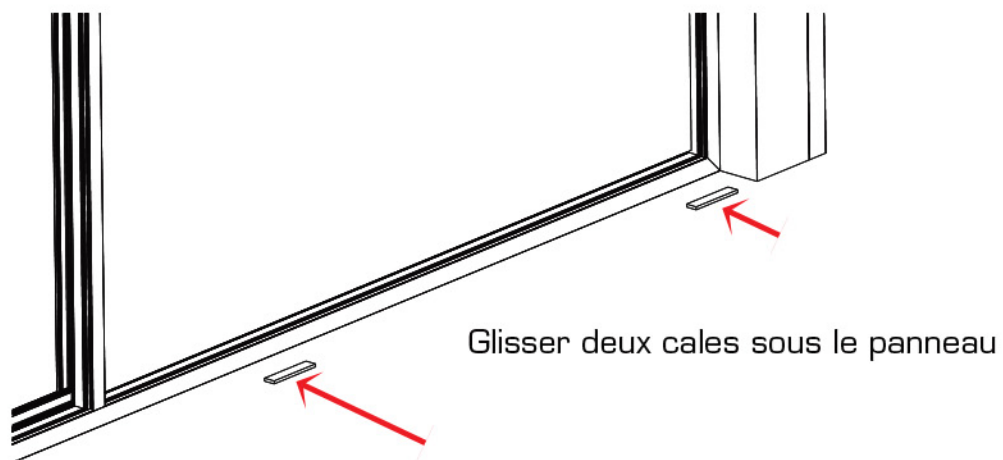

## **OU** Clippage des pareclozes de la lère trame

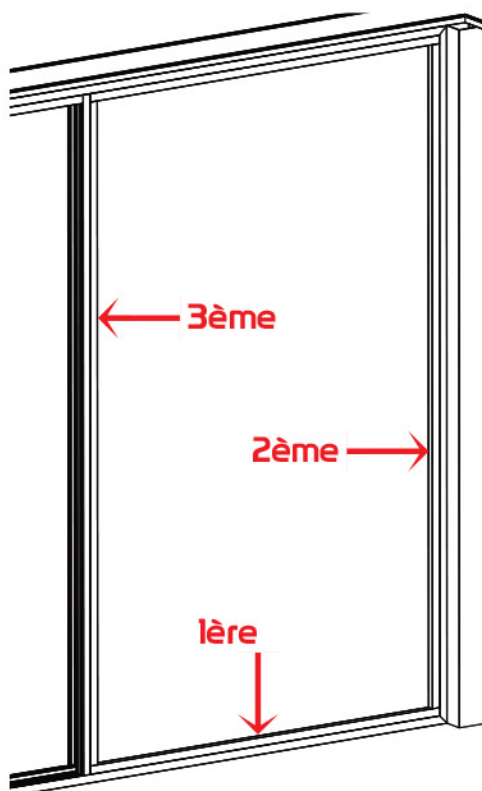

Clipper les trois dernières pareclozes

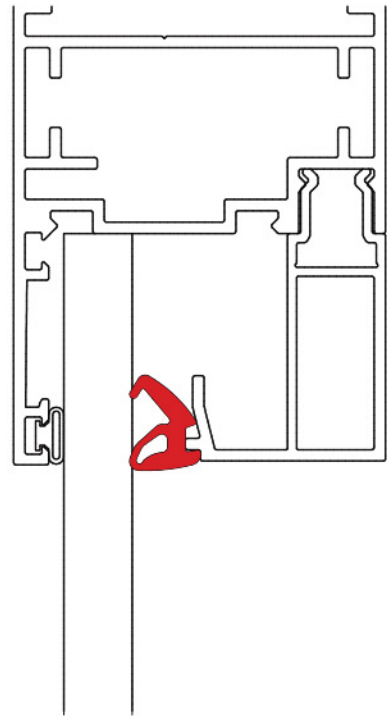
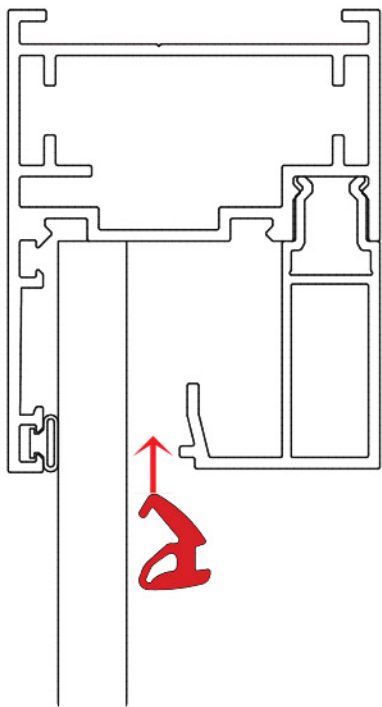

Insérer les joints à bourrer

**Réaliser ces opérations sur toutes les trames vitrées**



# Remplissage lames composites

**OU** Clipper les parclozes basses

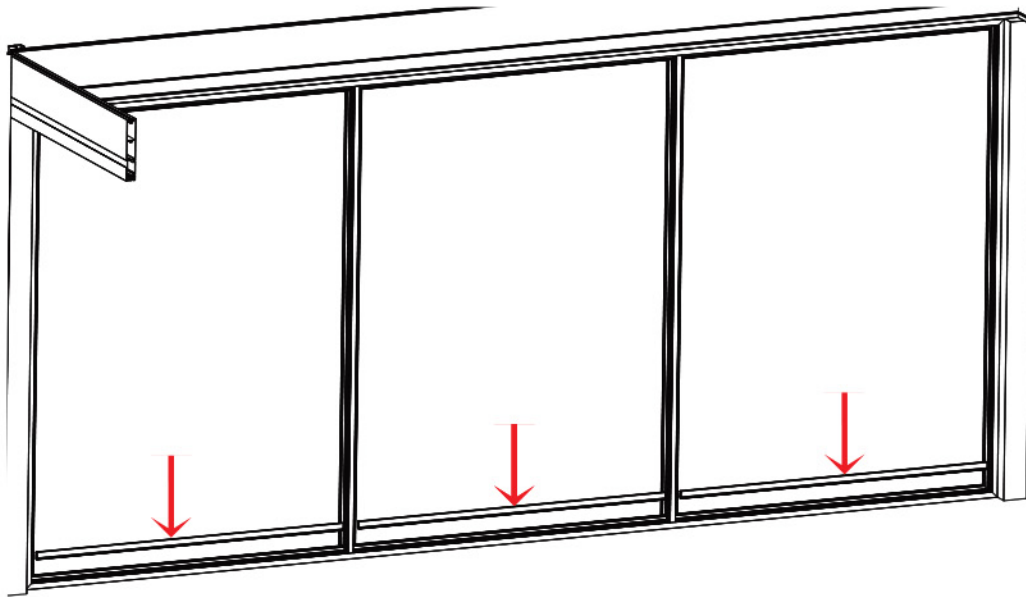

**OU** Insérer les lames

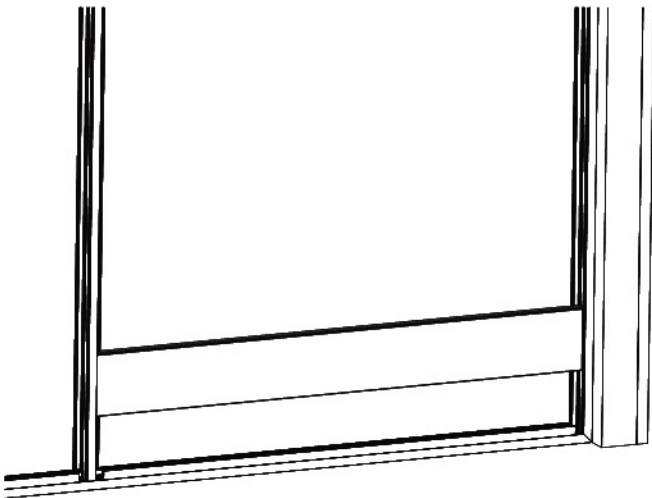

**OU** Clipper les parclozes basses

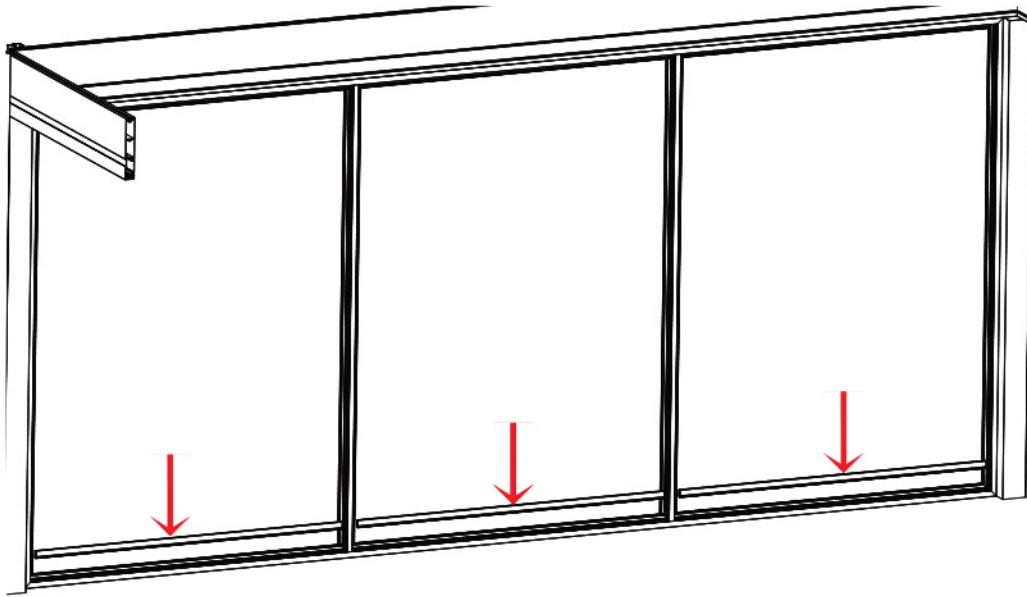

**OU** Insérer les lames

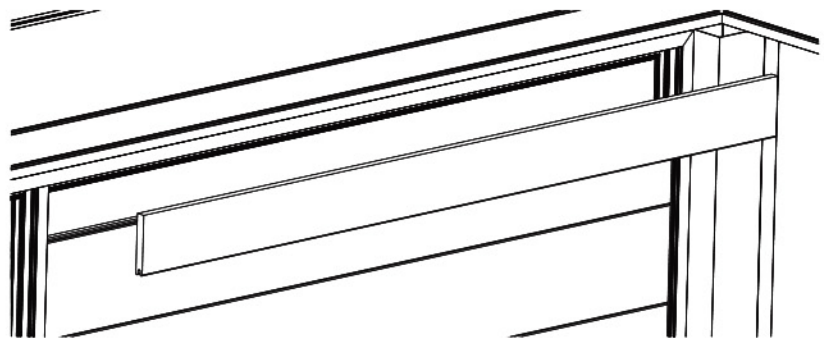
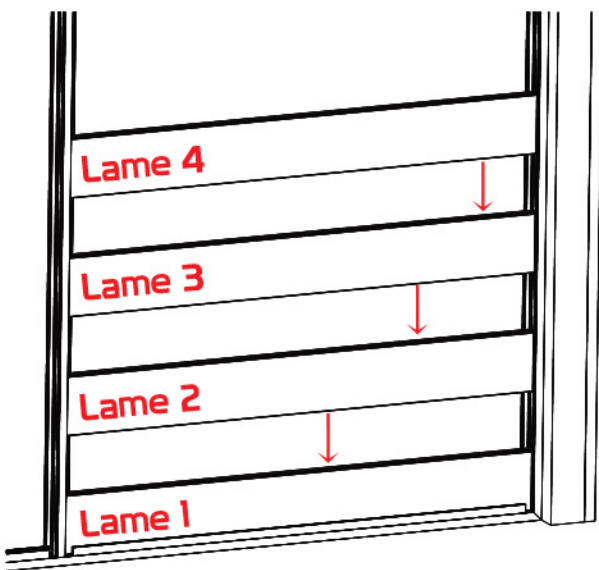

**OU** Clipser les parclozes hautes puis latérales

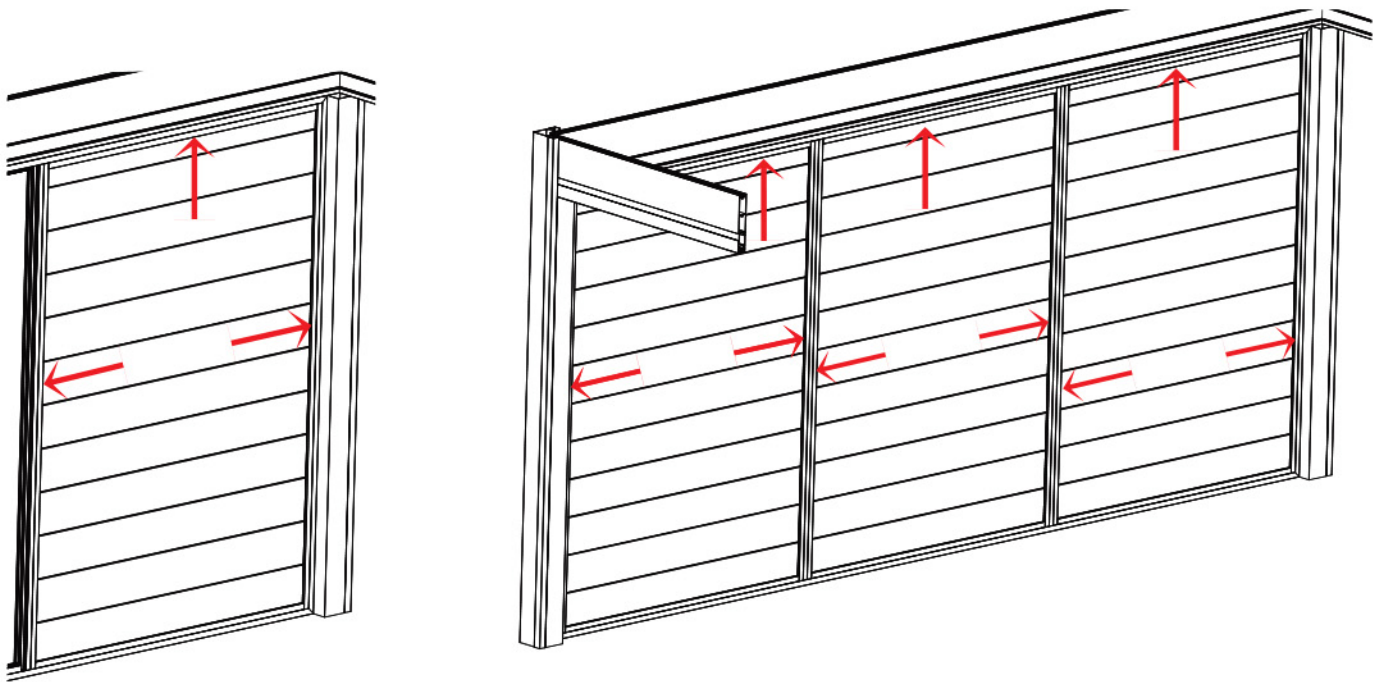

**OU** Montage du joint à boucher

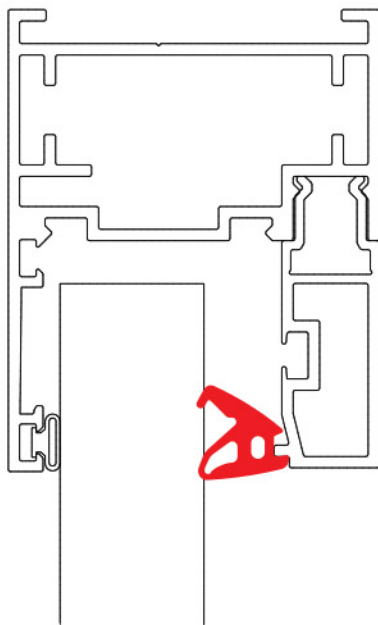

Insérer les joints à boucher

**Réaliser ces opérations sur toutes les trames composites**

# Remplissage brise-vue lames persiennes

**OU** Insertion des lames

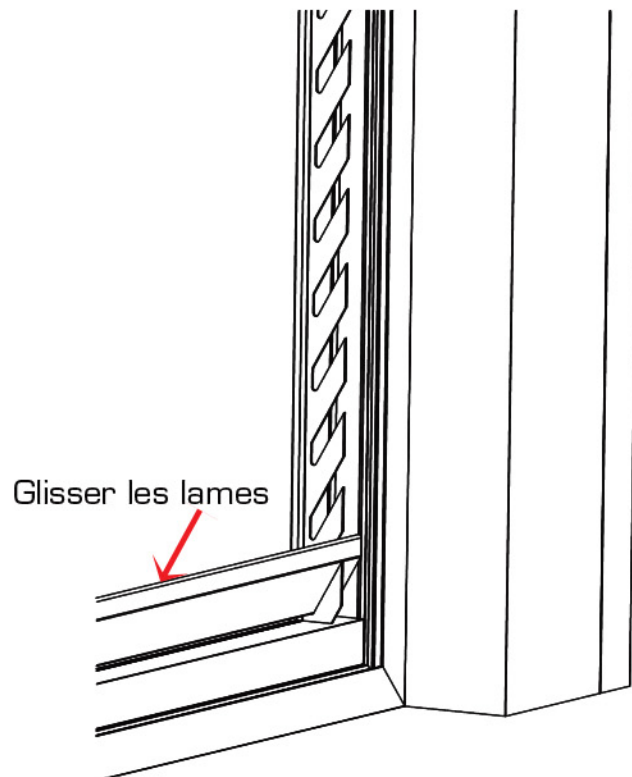
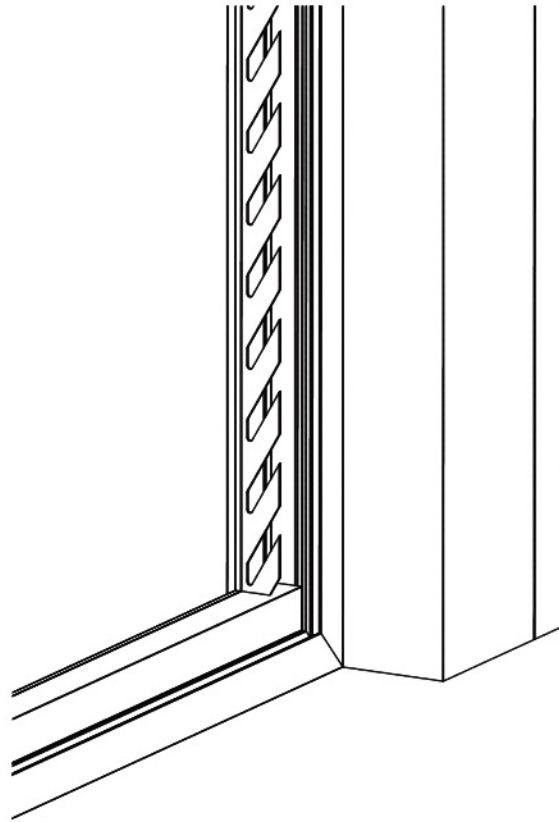

\*Les parcloles latérales sont pré-équipées d'un joint

